

F2J INDUSTRY

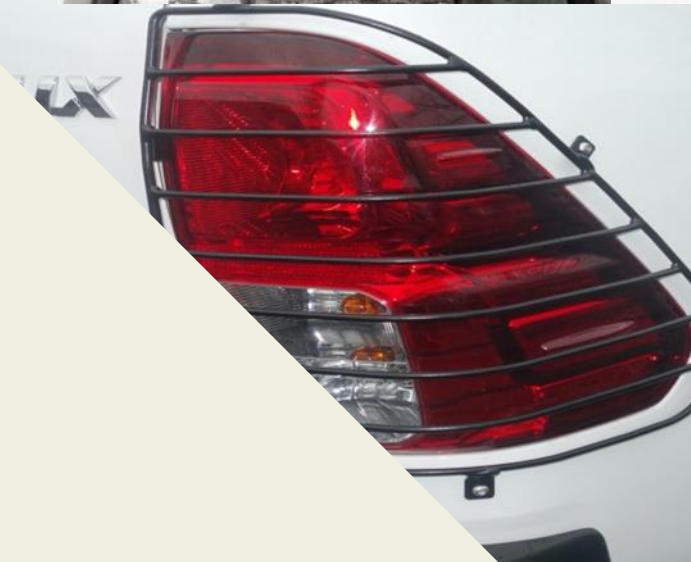

ABOUT F2J INDUSTRY....

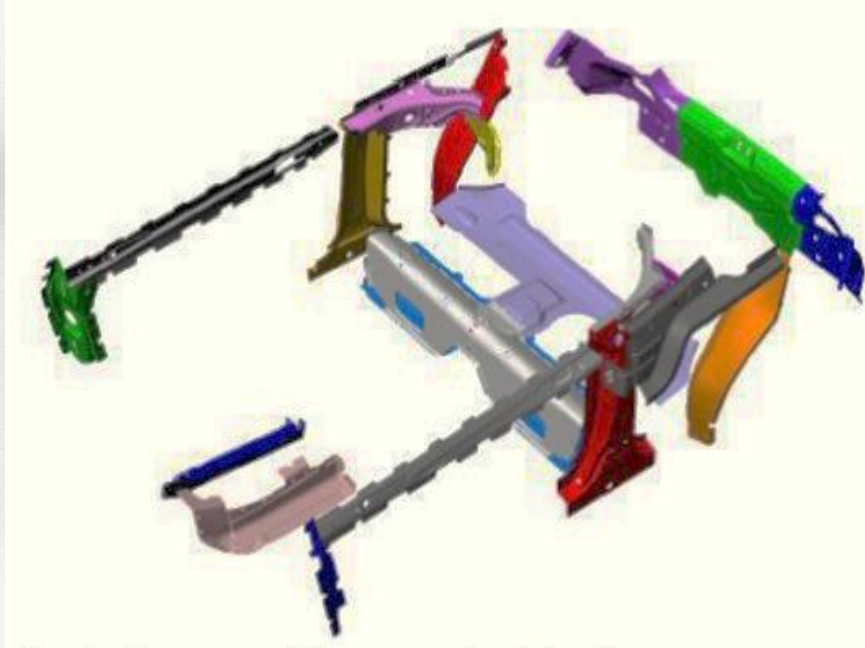

F2J INDUSTRY is a recognized and reliable international player in the subcontracting industry for ground transportation.

Following bankruptcy procedures or carveout of underperforming activities, F2J INDUSTRY has achieved over the last years successful M&A operations. F2J INDUSTRY has a talented and experimented staff who is highly motivated.

F2J INDUSTRY'S DEVELOPMENT STRATEGY

- Industrial excellence of current activities
- Sales growth of current activities
- External growth through new acquisitions



F2J INDUSTRY INDUSTRIAL GROUP OF COMPANIES



ABOUT F2J INDUSTRY...



Turnover: 195 M€

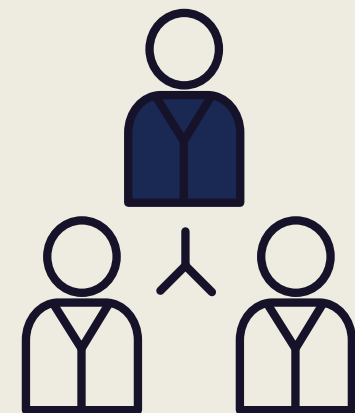

1 650 employees



4 plants in France
1 plant in Poland
3 plants in Argentina
1 plant in Brazil
2 plants in Spain
1 plant in USA



<http://f2jindustry.com>



<https://www.linkedin.com/company/f2jindustry>

PULLEYS & AUTOMATIC GEARBOX COMPONENTS

FOR THE AUTOMOTIVE INDUSTRY

Know-how and technical expertise are the keys of AGLA's success which can be representing by the technological processes & the materials



TURNOVER 2024 : 9,5 M €

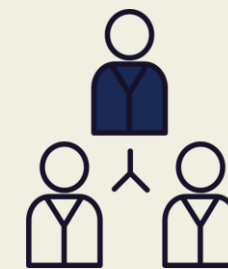

91 EMPLOYEES



26 000 M2 FACTORY SURFACE



PULLEYS & AUTOMATIC GEARBOX COMPONENTS



AGLA's know-how is significant because of its conception, design of products, planning and construction of the rolling engines used in production.

New projects in the field of hybrid engines & automatic transmissions, away from Diesel engines with which AGLA has

a strong and well-established history of success.





SPECIALIZED IN REMANUFACTURING OF ENGINES AND ENGINE COMPONENTS



TURNOVER 2024 : 10,9 M €

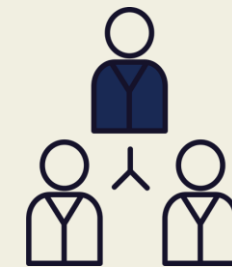

66 EMPLOYEES IN CHAUMONT



10 000 M2 FACTORY SURFACE

COMPLETE OR PARTIAL RENOVATION OF ENGINE COMPONENTS (COMPLETE ENGINE & GEARBOXES)

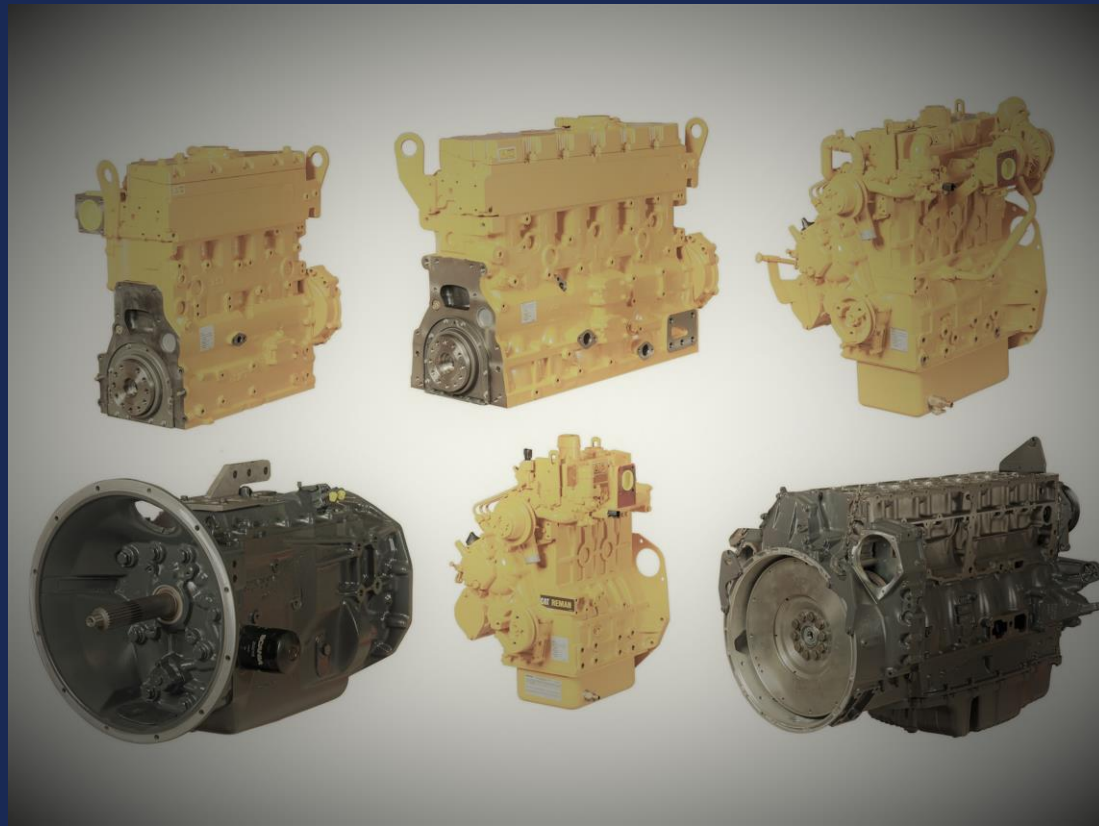

TURNOVER 2024 : 5,5 M €

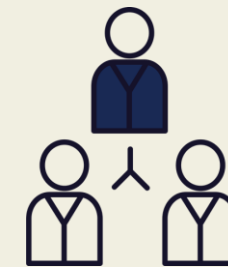

40 EMPLOYEES IN RADOM



3 200 M2 FACTORY SURFACE

WHAT'S REMANUFACTURING ?

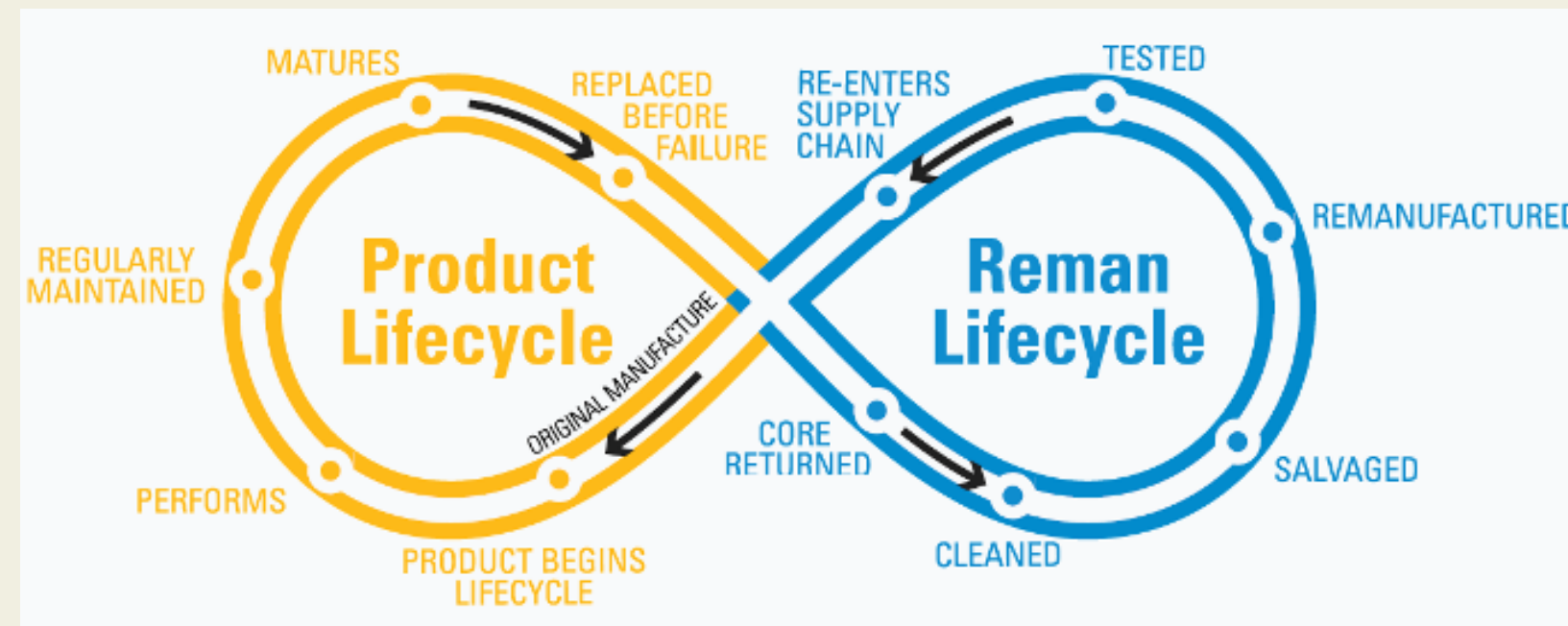

Remanufacturing :
Rebuilding of a product from a core in such a way that it is functionally identical to new part

BENEFITS ?



LOWER COST



WARRANTY



LOWER IMPACT ON THE ENVIRONMENT



HEAD LAMPS AND REAR LAMPS

Raw materials (thermoplastic pellets, molding mass, varnishes, aluminium) are used in this process of transformation into headlight components



TURNOVER 2024 : 29,4 M €

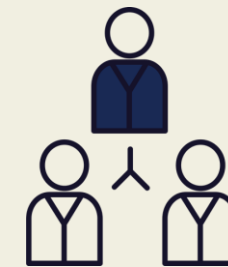

230 EMPLOYEES



12 353 M2 FACTORY SURFACE

HEADLIGHT COMPONENTS



Equipped with injection presses up to 1300 TO and assembly lines integrating 4.0 technologies, our F2J LIGHTING plant is able to respond to the latest markets for the manufacture of headlights and other plastic injection parts.



F2J STAMPING BESSINES



STAMPING, WELDING & ASSEMBLING

Wide range of products : car doors, tractor hood, lower plate, truck's structure parts, structure of race cars, aluminum development, car boxes, aluminum containers, train seat structures



TURNOVER 2024 : 13 M €



84 EMPLOYEES



12 000 M2 FACTORY SURFACE

DESIGN, REALIZATION, OPTIMIZATION



DESIGN : dedicated to the design of metal products and the support of customers in the industrialization process



REALIZATION : depending on the site's ability to produce highly technical products, requested by customers such as AGCO, PSA, VOLVO, Carrefour or Casino



OPTIMIZATION : in the work undertaken by F2J to make the plant a 4.0 plant by constantly optimizing its industrial tool



SERVICES COMPANY TO F2J GROUP

This company helps the F2J units to develop some important company departments, like Purchasing, New Technologies, Projects and Finance.

F2J DEVELOPMENT can also propose their services for the external companies in the above-mentioned fields.



TURNOVER 2024 : 400 K €



7 EMPLOYEES



SPECIALIZED IN THE MANUFACTURE OF GEARBOX PARTS



TURNOVER 2024 : 20 M €

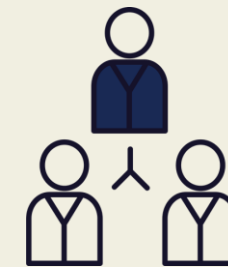

105 EMPLOYEES



18 894 M2 FACTORY SURFACE

LEADERS IN THE MANUFACTURE OF MACHINED PARTS AND MODULES PRODUCTION



Production of 4 500 000 components per year

In the broader vision of the F2J Group, the Valentigney site (25) is fully in line with a 4.0 investment dynamic to be able to respond even better to customers and position itself on new markets.



F2J LIGHTING INTERLARGOS



HEADLAMPS AND REAR LAMPS INJECTION & ASSEMBLY



TURNOVER 2024 : 37 M €



395 EMPLOYEES



22 000 M2 FACTORY SURFACE

LIGHTING PRODUCTS

Specialized in lighting products for the automotive market, for the light and heavy vehicles, also for motorcycle segments, among others, always seeking for the best solutions for our customers based on innovative, sustainable and robust technologies.

Our equipment is the latest generation to support all market needs and our technical team is constantly trained to keep up with and exceed customer expectations.

Capacity of headlamps production : 4.800 parts per day

Capacity of rear lamps production : 5.500 parts per day



INTERIOR AND EXTERIOR PLASTIC PARTS FOR AUTOMOTIVE MARKET



TURNOVER 2024 : 25,8 M €

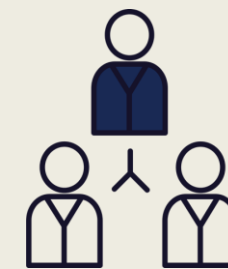

330 EMPLOYEES



16 000 M2 FACTORY SURFACE

F2J TECHPLAST CORDOBA PRODUCTS



L'Equipe Monteur S.A. main activity is the manufacturing of large plastic assembled car parts for the interior and exterior of vehicles and supplies its products to the most important OEMs in Argentina. L'Equipe Monteur S.A. has two modern plants in Argentina, located in the capital city of Cordoba and in the city of Garin in Buenos Aires Province.



F2J TECHPLAST BUENOS AIRES



INTERIOR AND EXTERIOR PLASTIC PARTS FOR AUTOMOTIVE MARKET



TURNOVER 2024 : 5,4 M €



135 EMPLOYEES



12 000 M2 FACTORY SURFACE

F2J TECHPLAST BUENOS AIRES PRODUCTS

L'Equipe Monteur S.A. main activity is the manufacturing of large plastic assembled car parts for the interior and exterior of vehicles and supplies its products to the most important OEMs in Argentina. L'Equipe Monteur S.A. has two modern plants in Argentina, located in the capital city of Cordoba and in the city of Garin in Buenos Aires Province.



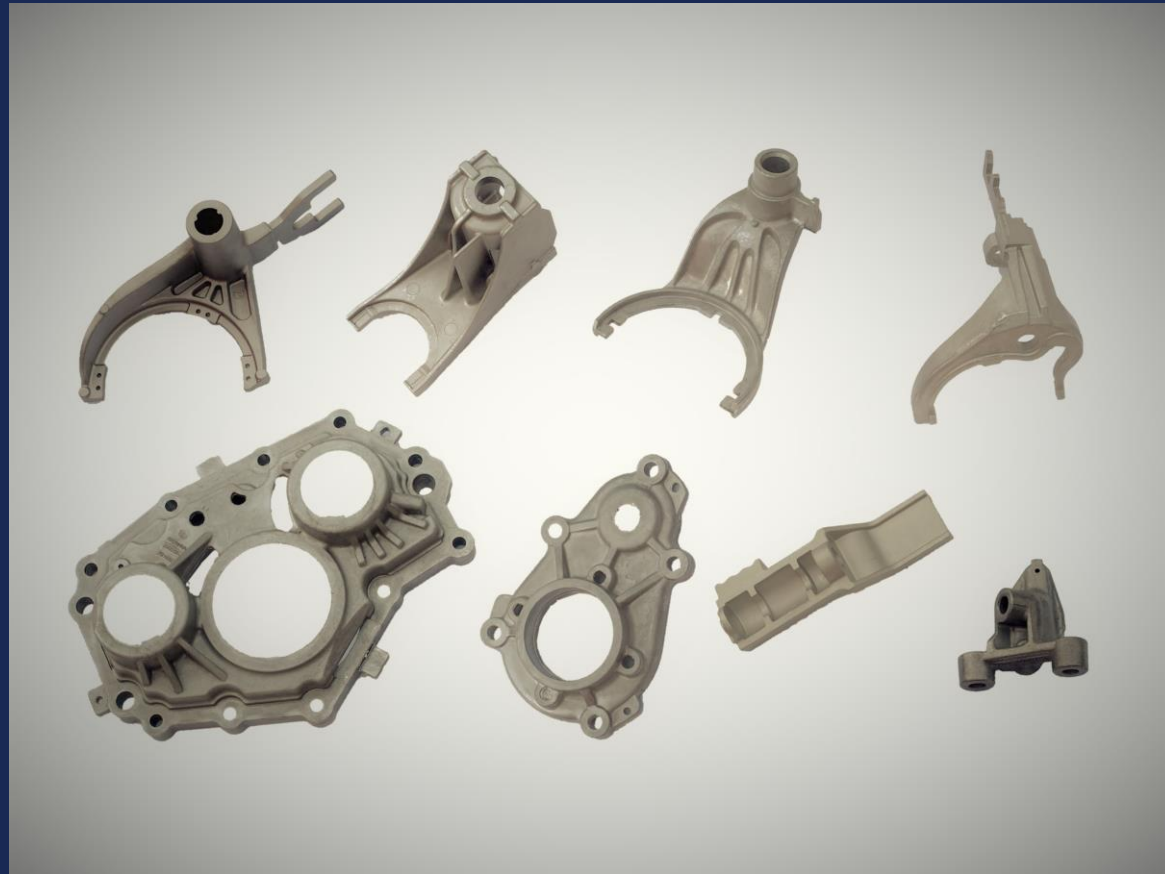

Aluminium Foundry



TURNOVER 2024 : 6,5 M €



34 EMPLOYEES



7 000 M2 FACTORY SURFACE



F2J PAMPLONA PRODUCTS

F2J PAMPLONA is developing, validating and manufacturing precision components for all major automotive brands since more than 50 years.

A wide range of technologies together with our know-how and good practices are integrated in our manufacturing sites where we are able to provide engineer solutions designing and supplying a final product fulfilling the customer required specifications.

We manufacture components made of different metallic materials where our aluminum casting site is focused in automotive lightweight solutions.

Our customer focus culture is one of the main values that are part of our daily basis.

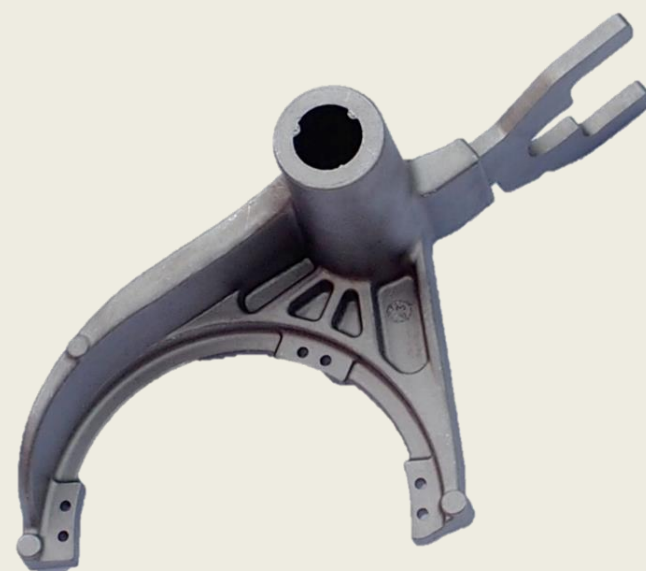



MACHINING OF AUTOMOTIVE PARTS



TURNOVER 2024 : 23 M €



95 EMPLOYEES



6 000 M2 FACTORY SURFACE

MIASA ZUERA PRODUCTS



MIASA ZUERA is developing, validating and manufacturing precision components for all major automotive brands since more than 50 years.

A wide range of technologies together with our know-how and good practices are integrated in our manufacturing sites where we are able to provide engineer solutions designing and supplying a final product fulfilling the customer required specifications.

We manufacture and machine components made of different metallic materials for the automotive market. The casting can come from F2J PAMPLONA or by other casting's partners.

Our customer focus culture is one of the main values that are part of our daily basis.



MIASA AUTOMOTIVE

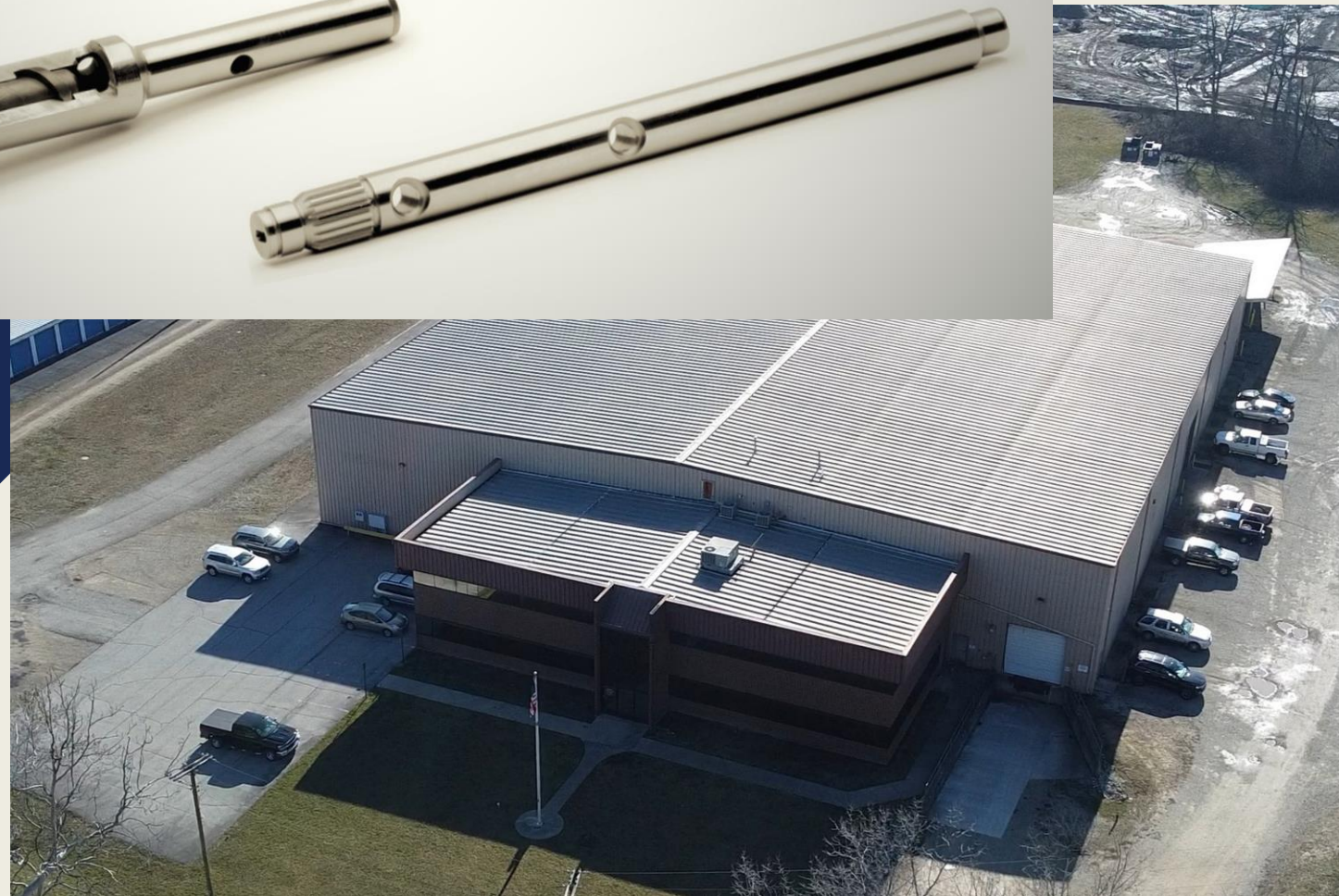
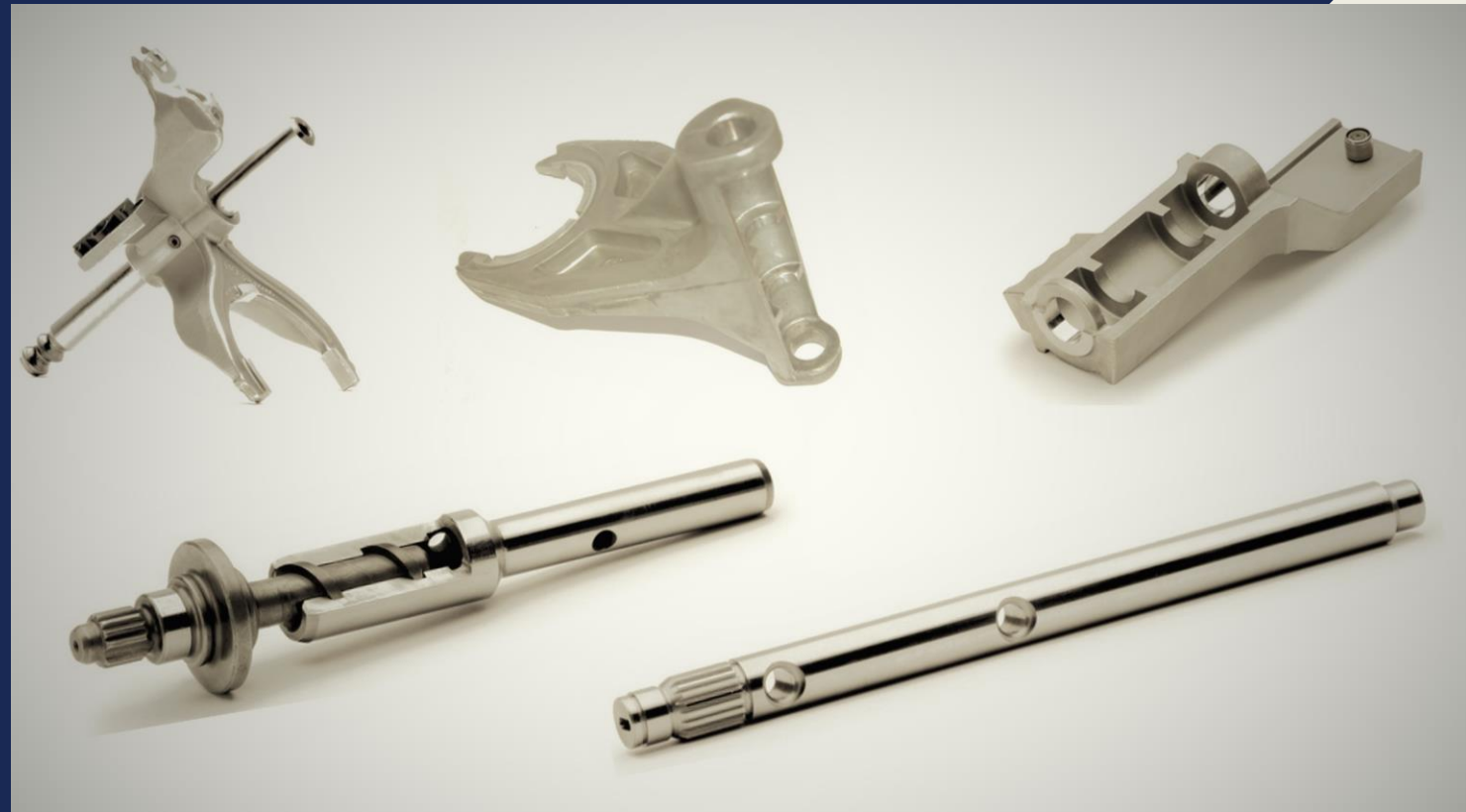

MACHINING OF AUTOMOTIVE PARTS



TURNOVER 2024 : 8,8 M €



45 EMPLOYEES



5 000 M2 FACTORY SURFACE

MIASA AUTOMOTIVE PRODUCTS



MIASA AUTOMOTIVE is developing, validating and manufacturing precision components for all major automotive brands since more than 50 years.

A wide range of technologies together with our know-how and good practices are integrated in our manufacturing sites where we are able to provide engineer solutions designing and supplying a final product fulfilling the customer required specifications.

We manufacture components made of different metallic materials where our aluminum casting site is focused in automotive lightweight solutions.

Our customer focus culture is one of the main values that are part of our daily basis.

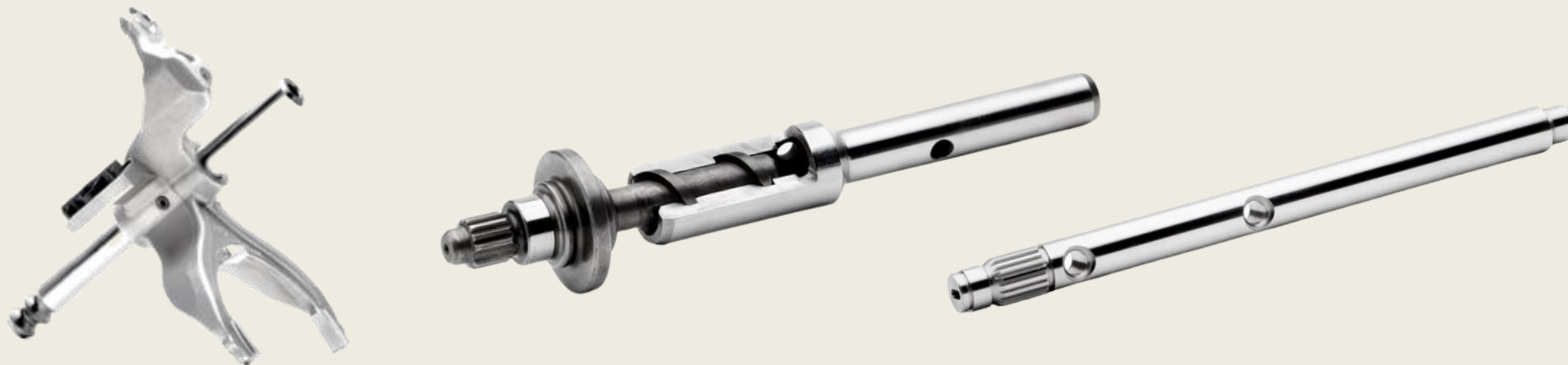

OUR CUSTOMERS



RENAULT SPORT



Mercedes-Benz

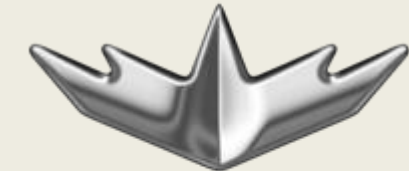

CHATENET



THANK YOU FOR YOUR ATTENTION

FAGOR

